

Cantidad de artículos por referencia *number of items per reference* : 1ud

Recomendaciones para el desembalaje: Vigilar al abrir con un elemento afilado el embalaje. Guardar el embalaje unos días para en caso de devolución y mantener las instrucciones de montaje para posibles consultas

Recommendations for unpacking: *Be careful when opening the packaging with a sharp object. Keep the packaging for a few days in case of return and keep the assembly instructions for future reference.*

Sugerencias de montaje: sólo hay que montar las bases. Comprobar y clasificar todos los herrajes antes de comenzar el montaje. Montar sobre una superficie blanda

Assembly tips: *only the legs need to be assembled. Check and sort all fittings before starting assembly. Mount on a soft surface*

EMBALAJE | PACKAGING

Tipo <i>Type</i>	uds/caja <i>s/carton</i>	ancho <i>length</i>	fondo <i>width</i>	alto <i>height</i>	volumen <i>volumen</i>	P. N <i>N.W</i>	P.B. <i>G.W</i>
Caja 1	4	55,5	51	8,5	0,024	14	16
Caja 2	1	207,5	57,5	74,5	0,89	82	84
Caja 3	2	62	24	15,5	0,023	3	5

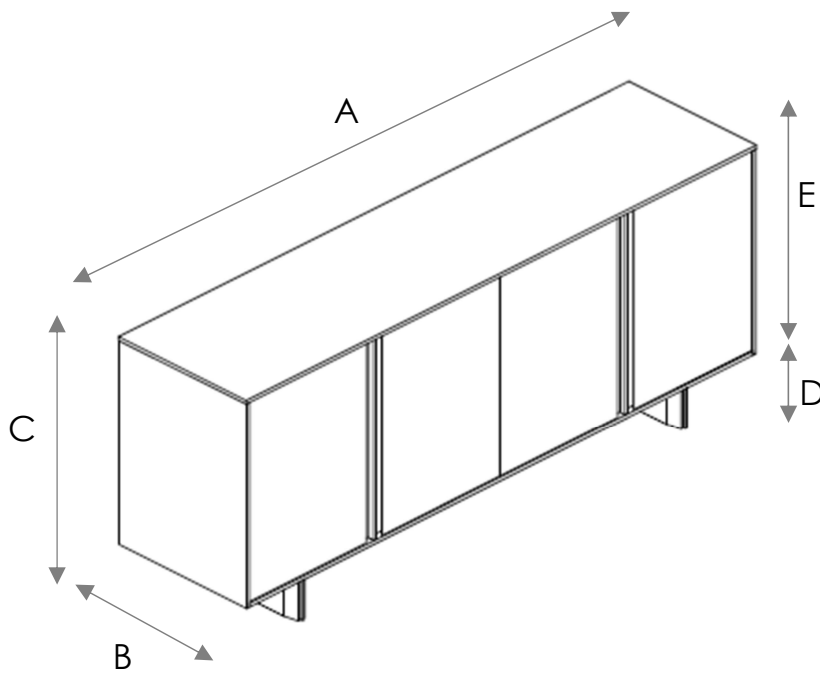

DIMENSIONES
MEASUREMENTS
 200x50x81,6cm

ancho x fondo x alto
 length x width x height

A	200 cm
B	50 cm
C	81,6 cm
D	15 cm
E	66,6 cm

PIEZAS PIECES

1_4UD
 Baldas vidrio
 Glass shelves

2_1UD
 Aparador
 Buffet

3_1SET
 1 Set de patas
 1 Set of legs

A_ M8X160mm | 4UD



B_ 5mm | 1UD



C_ Ø20xØ10x2 | 4UD



D_ Ø15 | 6UD



E_ Ø8x30 | 6UD



F_ Ø21 | 6UD



G_ M8X18 | 4UD



H_ Ø5 | 16UD



I_ 2UD



J_ 4UD



K_ 3,5x30 | 4UD



MONTAJE ASSEMBLY

Paso 1 *Step 1*

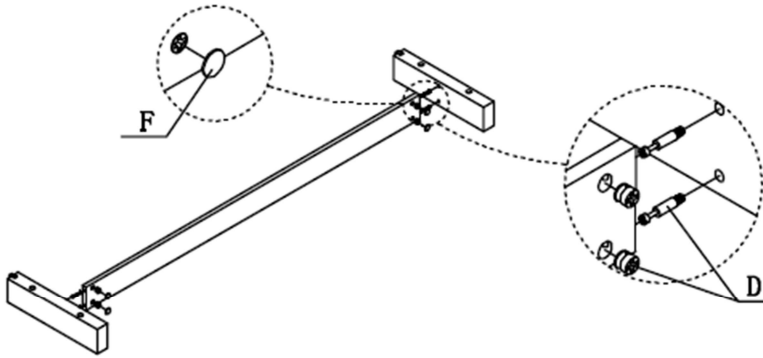

Paso 2 *Step 2*

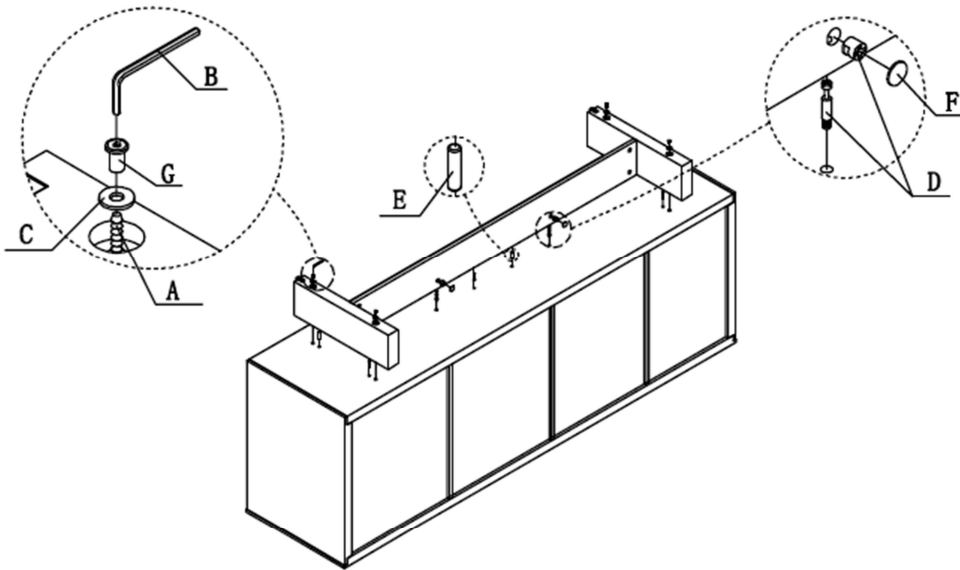

Paso 3 *Step 3*

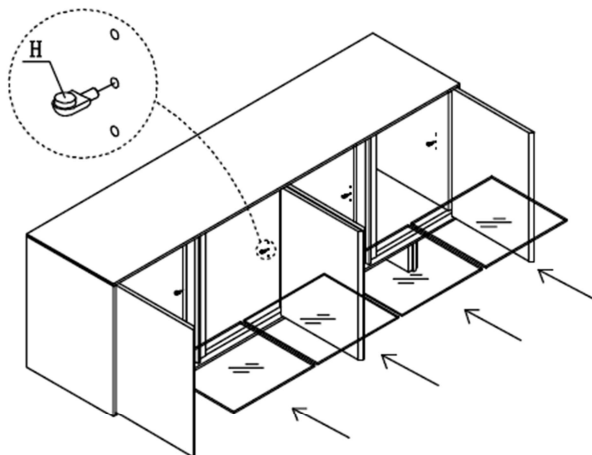

MONTAJE ASSEMBLY

Paso 4 Step 4

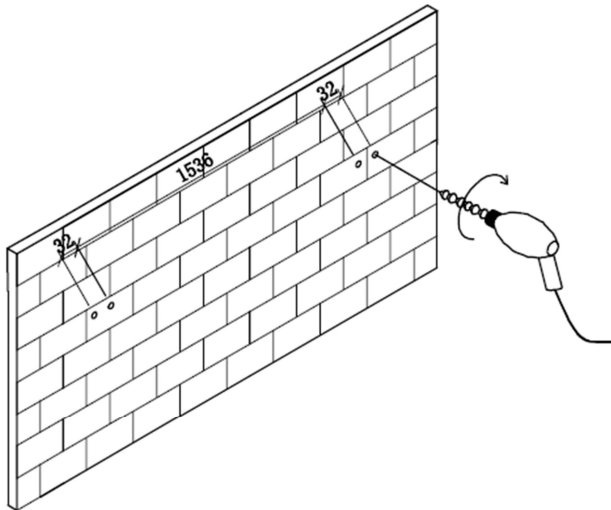

Paso 5 Step 5

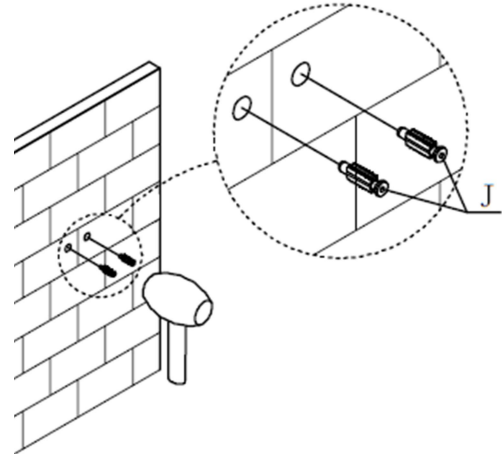

Paso 6 Step 6

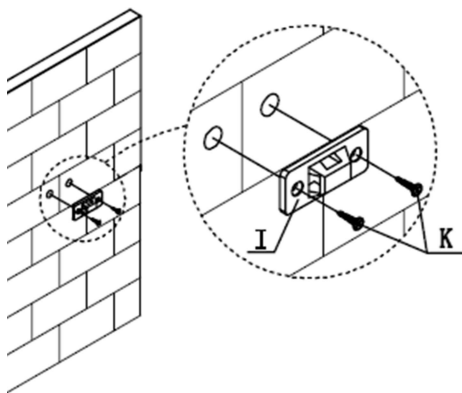

Resultado Finish

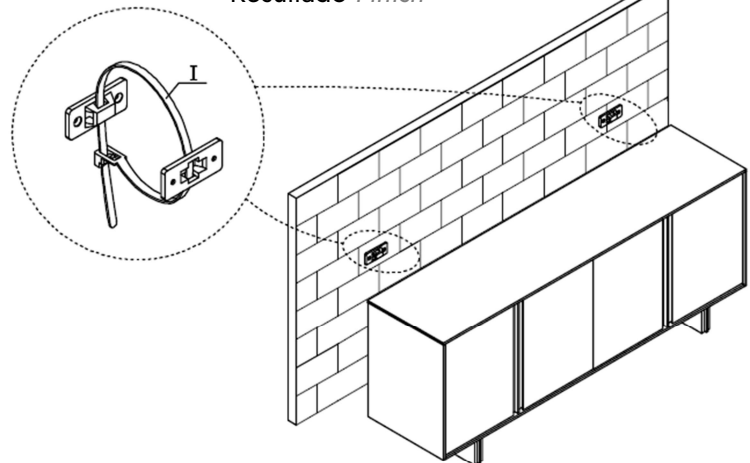

Kit Anti-TiP

Se recomienda instalar el Kit Anti-Vuelco incluido con el producto para mayor seguridad y estabilidad.. Es esencial utilizar anclajes de pared adecuados para su tipo de pared (es decir, yeso, paneles de yeso ,hormigón,etc.), junto con los tornillos adecuados, para un montaje correcto. Los tornillos incluidos en este kit antivuelco pueden no ser adecuados para todas las paredes. Consulte a un profesional cualificado.

Kit Anti-TiP

It is recommended that the Anti-Tip Kit included with this product be installed for added safety and stability. It is essential to use wall anchors appropriate for your wall type (i.e.plaster,drywall, concrete,etc.),along with appropriate screws,for proper mounting.The screws included in this Anti-Tip Kit may not be suited for all wall types. Mounting to wood studs is recommended.Consult a qualified professional or your local hardware store for appropriate mounting hardware suited for your specificwall medium.

INSTRUCCIONES DE LIMPIEZA PRODUCT CARE

1. NO USAR NUNCA PRODUCTOS QUÍMICOS NI ABRASIVOS QUE PUEDAN DAÑAR EL ARTÍCULO.
2. LIMPIAR SIEMPRE CON PAÑO SECO Y LIMPIO.
3. LA LUZ SOLAR DIRECTA PUEDE DAÑAR EL ARTÍCULO.
4. SITÚE SIEMPRE SU MOBILIARIO A UNA DISTANCIA NO INFERIOR A 70 CM DE UNA FUENTE DIRECTA DE CALOR, TALES COMO CHIMENEAS, RADIADORES, ETC.

1. NEVER USE HOUSEHOLD CLEANERS, CLEANING SOLUTIONS OR HARSH CHEMICALS TO CLEAN THE FURNITURE.
2. CLEAN WITH A DRY AND SOFT CLOTH
3. DIRECT SUNLIGHT CAN BE HARMFUL TO THIS FURNITURE. YOU MUST AVOID EXPOSURE TO DIRECT SUNLIGHT
4. ALWAYS PLACE THE FURNITURE AT LEAST 70CM AWAY FROM ANY DIRECT SOURCE OF HEAT, SUCH AS FIREPLACES, RADIATORS, ETC.